

VINCENT

- PODESIVI GLAVONASLON PO VISINI
 - NASLONSKI I SEDEČI JASTUCI SU IZRAĐENI OD NEDEFORMIRAJUĆI VISOKO OTPORNOG POLIURETANA
 - METALNE NOGICE ASL 227 h-12sm
- ***NAPOMENA : dozvoljeni odstup od tapacirane dimenzije: +/- 2cm.

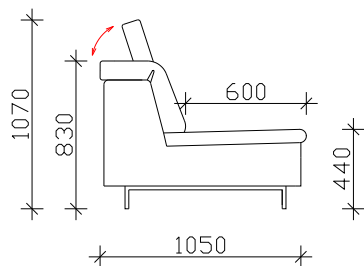

IZGLEDI



BOCNI IZGLED

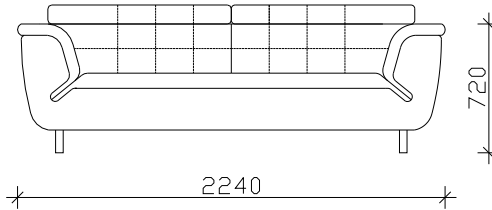

FRONTALNI IZGLED

SOFA ELEMENTI

FOTELJA

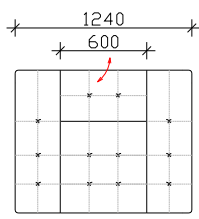

TROSJED

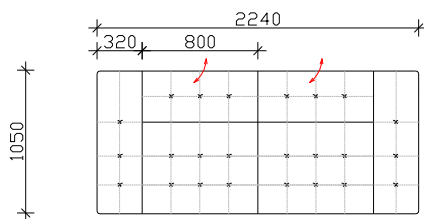

DVOSJED

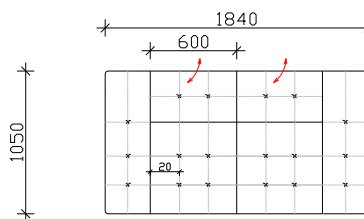

TABURE

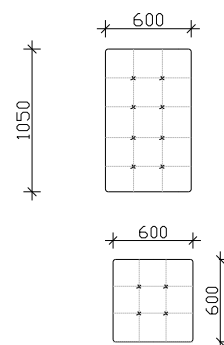

UGAONI ELEMENTI

UGAONI TROSJED

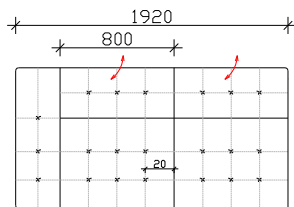

UGAONI DVOSJED

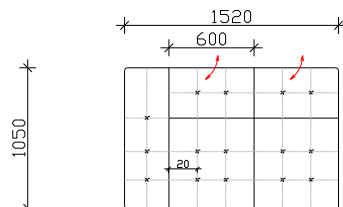

FIKSNI UGAO

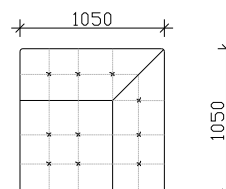

UGAO

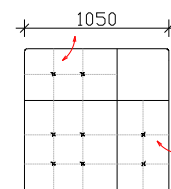

RELAKS 112

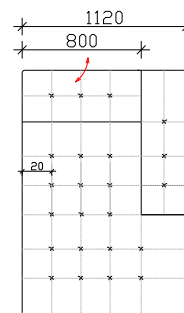

RELAKS 92

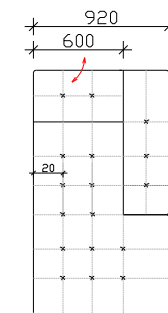

VINCENT

- PODESIVI GLAVONASLON PO VISINI
 - NASLONSKI I SEDEČI JASTUCI SU IZRAĐENI OD NEDEFORMIRAJUĆI VISOKO OTPORNOG POLIURETANA
 - METALNE NOGICE ASL 227 h-12sm
- ***NAPOMENA : dozvoljeni odstup od tapacirane dimenzije: +/- 2cm.



TROSJED PRODUŽENI

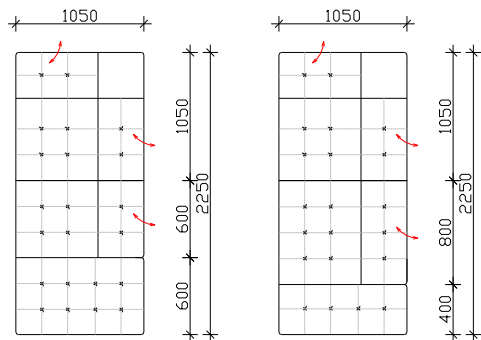

TROSJED PRODUŽENI SA FIKSNI UGAO

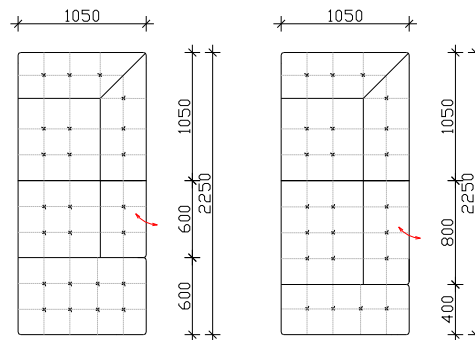

VARIJANTE

UGAONI TROSJED + UGAO + UGAONI DVOSJED

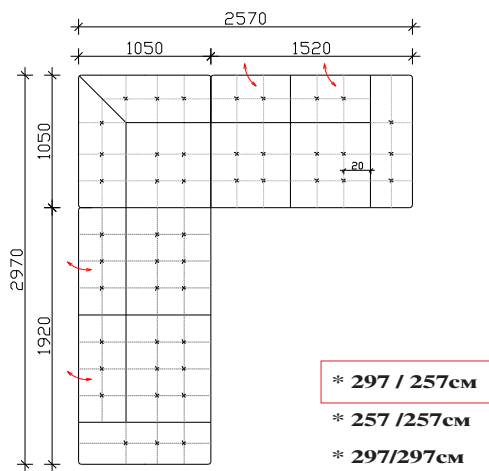

UGAONI + RELAKS 112 TROSJED

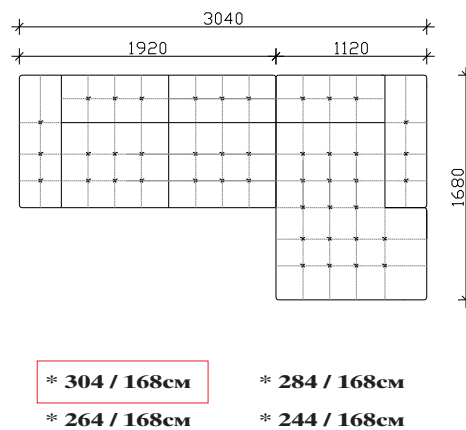

UGAONI TROSJED + TROSJED PRODUŽENI

