

STEP

- GARNITURA IZRADZENA SA NAVLAKOM
- NASLON I SEDENJE - PERJE.
- DEMONTAZNE STRANICE
- PLASTICNE NOGICE -H=4 sm

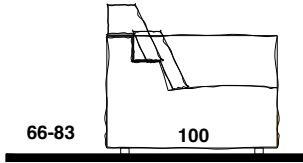

SOFA ELEMENTI



STRANICNI IZGLED

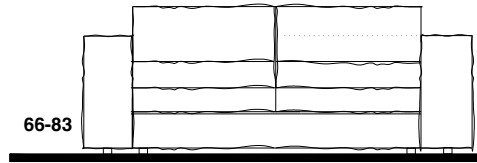

IZGLED

TROSED

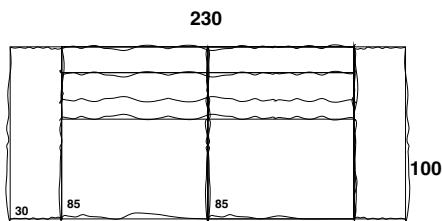

DVOSED

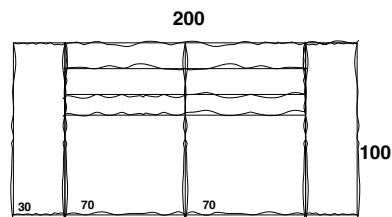

UG.TROSED

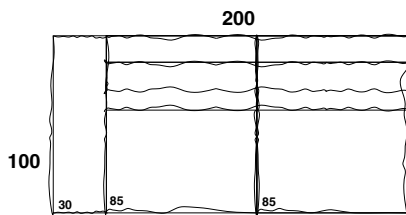

UG.DVOSED

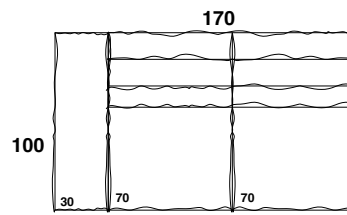

RELAKS 100

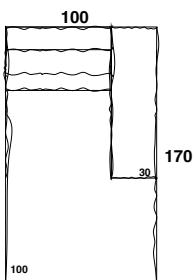

RELAKS 115

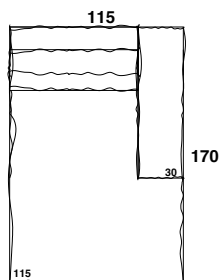

UGAONI EL.

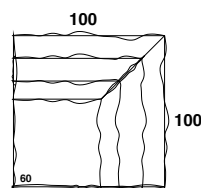

TABURE

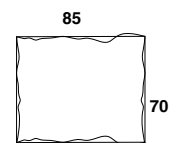

STEP

- GARNITURA IZRADZENA S NAVLAKOM
- NASLON I SEDENJE - PERJE.
- DEMONTAZNE STRANICE
- PLASTICNE NOGICE -H=4 sm



SOFA ELEMENTI

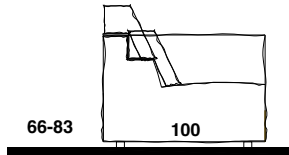

IZGLED SA STRANE

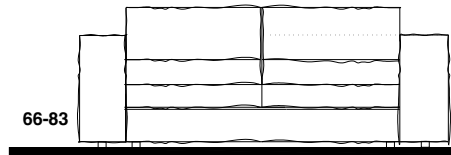

IZGLED

UGAONE VARIJANTE

UG.TROSED+ RELAKS 115

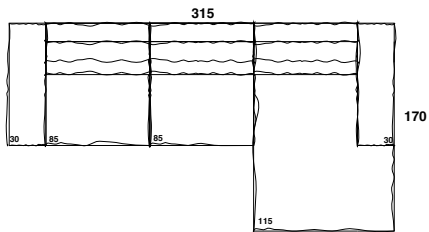

2UG,TROSEDA
+UGAO .EL.

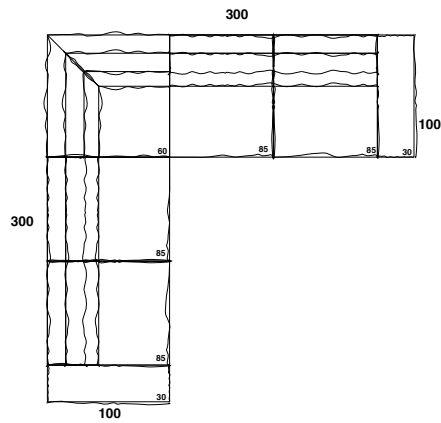

2 UG.DVOSEDI
+UG.EL.

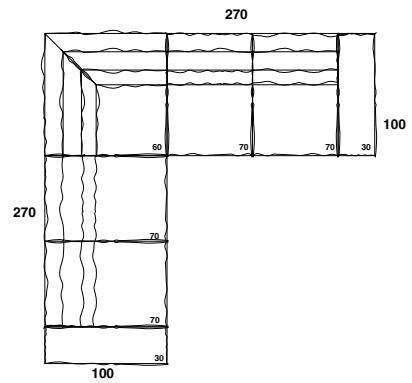

UG.TROSED+ RELAKS 100

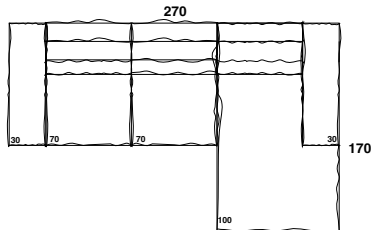

2UG,TROSEDA
+UG.EL.+REL.115

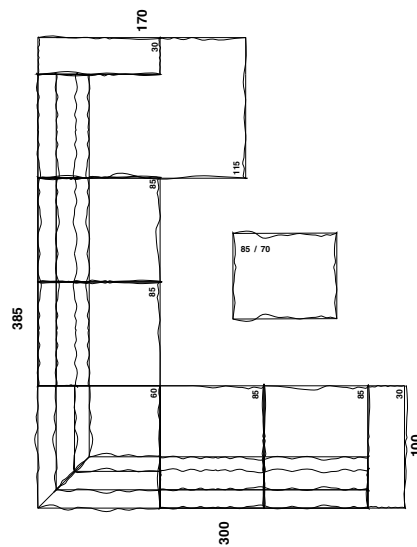

2 UG.DVOSEDA
+UG.EL.+REL.100

